

Revision 1

January 2009



BATCA
fitness systems · usa

B-6

3-Tier Dumbbell Rack

Owner's Manual

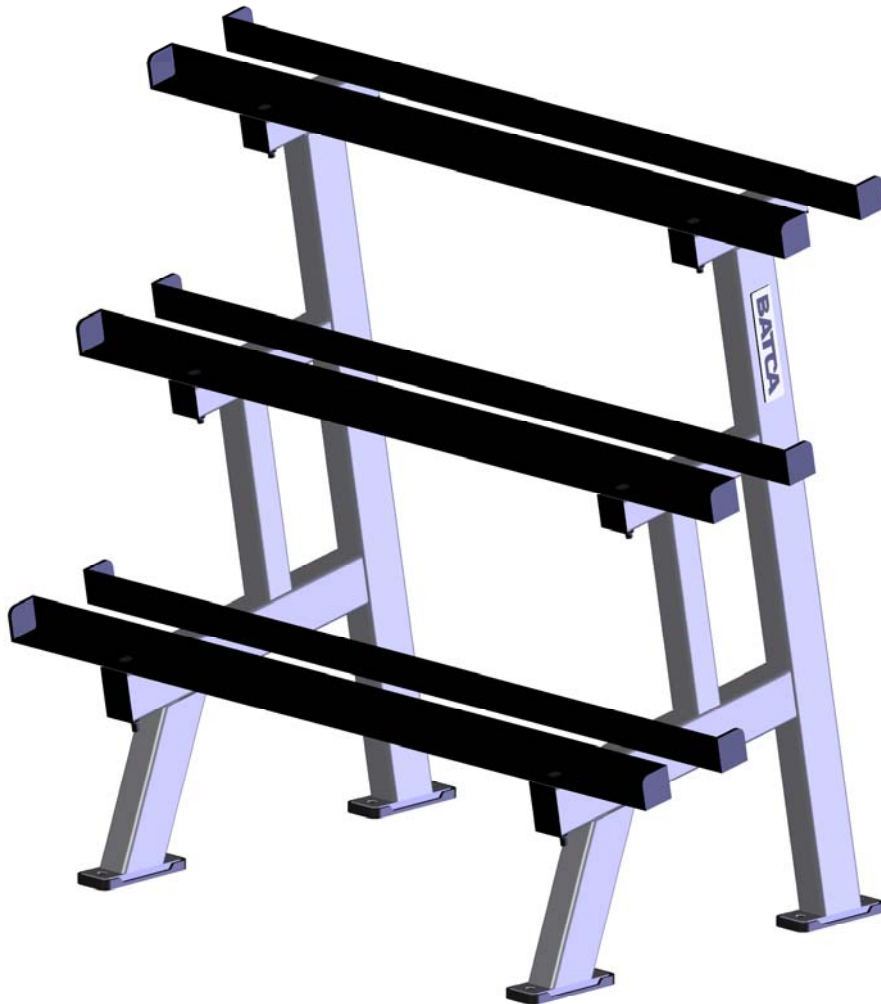

Record Serial Number Here

Date of Purchase

Batca Fitness Systems
Tel. (919) 255-1233
www.batcafitness.com

Instructions

Congratulations on the purchase of your new Batca B-6 3 Tier Dumbbell Rack. This gym will provide you with a lifetime of enjoyment to meet your strength training needs. Batca Fitness Systems strives to build the best quality gyms and to package these gyms in such a way to avoid any damage during shipping.

In order to get started with your assembly you should first familiarize yourself with this manual. It is recommended that you read through each step thoroughly before you begin. Begin by opening your boxes and separating all of your parts. Verify that all parts are accounted for and have no damage. When all parts are accounted for, you may begin your assembly. Some items may have been pre-assembled for your convenience. Please note that hardware quantities shown reflect total quantities for your gym and may not reflect actual quantities in each bag. Assemble your gym on a solid level surface. This will ensure the best possible performance, function, and safety for the gym and your workout.

Assemble your gym according to the step by step instructions found in this manual. Failure to do so will void your warranty and may result in personal injury. After assembly, you should check each station to ensure correct operation. If a problem arises, recheck your assembly with these instructions to verify correct assembly. If you are unable to correct a problem or have questions with your assembly please contact your authorized Batca dealer.

Warning

Batca Fitness Systems has built this gym to give you a safe, effective and enjoyable workout. However, there is a risk assumed by individuals who use this type of equipment. It is very important that all warnings and instructions are read and followed before beginning any exercise program.

It is also very important to read and follow the preventative maintenance schedule described in this manual. If any of the warning labels or stickers are worn, faded, torn, scratched or missing they should be replaced immediately.

WARNING: There is a risk assumed by individuals who use this type of equipment. To minimize risk always follow these rules.

- 1) It is essential that you consult with your physician before beginning any exercise program.
- 2) Inspect equipment before each use for loose, worn, or frayed parts (including cables, nuts and bolts). Replace parts at first signs of wear (use only genuine BATCA replacement parts). Use of equipment that is damaged, worn, frayed or not completely assembled on a solid, level surface may result in injury.
- 3) Make sure all adjustment pins are fully engaged before using equipment.
- 4) Keep all parts of the body and clothing outside the path of any moving parts of the gym. Be alert to the possibility of injury. Do not be careless.
- 5) Minors and children should not be allowed to play on or around this gym.
- 6) If you have any questions on proper use or maintenance of this gym, do not hesitate to call your local BATCA FITNESS SYSTEMS distributor or BATCA FITNESS SYSTEMS at (919) 255-1233. www.batcafitness.com

Table of Contents

	<u>Page</u>		<u>Page</u>
Instructions	2	Maintenance	9
Parts Listing	3	Warranty	10
Hardware Comparison	4-7	Floor Plan Layout	11
Main Assembly	8		

Frame Components

ITEM NO.	PART NUMBER	DESCRIPTION	QTY.
1	BFM-10732	3-Tier Side Frame	2
2	BFM-10730	Angle Iron Support	6

Hardware

ITEM NO.	PART NUMBER	DESCRIPTION	QTY.
3	BFH-50255	Rubber Foot	4
4	BFH-50251	3/8" Flat Washer Black	12
5	BFH-50265	FHSCS 3/8"-16 X 4"	4
6	BFH-50323	FHSCS 3/8"-16 X 3"	8
7	BFH-50155	3/8"-16 Nylock (Black)	12

Tools Required

- 3/8" Wrench
- 3/8" Ratchet
- Tape Measure

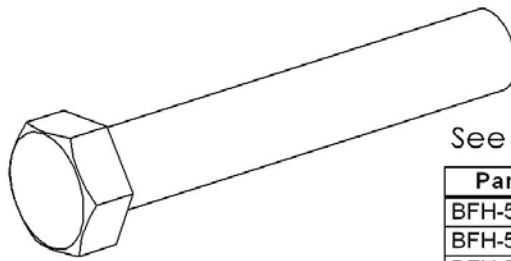
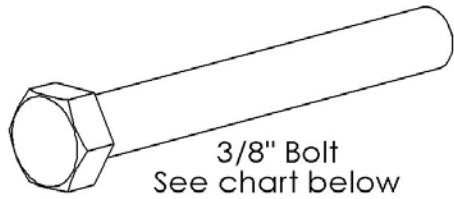

Part #	Size
BFH-50254	3/8" x 3/4"
BFH-50118	3/8" x 1"
BFH-50119	3/8" x 1 1/4"
BFH-50120	3/8" x 1 1/2"
BFH-50285	3/8" x 1 3/4"
BFH-50121	3/8" x 2"
BFH-50122	3/8" x 2 1/4"
BFH-50123	3/8" x 2 1/2"
BFH-50124	3/8" x 2 3/4"
BFH-50125	3/8" x 3"
BFH-50126	3/8" x 3 1/4"
BFH-50127	3/8" x 3 1/2"
BFH-50128	3/8" x 3 3/4"
BFH-50129	3/8" x 4"
BFH-50130	3/8" x 4 1/4"
BFH-50131	3/8" x 4 1/2"
BFH-50274	3/8" x 4 3/4"
BFH-50279	3/8" x 5"
BFH-50270	3/8" x 5 1/4"
BFH-50132	3/8" x 5 1/2"
BFH-50133	3/8" x 6 1/2"
BFH-50298	3/8" x 8 3/4"
BFH-50134	3/8" x 9"

Part #	Size
BFH-50135	1/2" x 2 3/4"
BFH-50136	1/2" x 3"
BFH-50137	1/2" x 3 1/4"
BFH-50138	1/2" x 3 1/2"
BFH-50139	1/2" x 4 1/4"
BFH-50140	1/2" x 4 1/2"
BFH-50141	1/2" x 5 1/2"

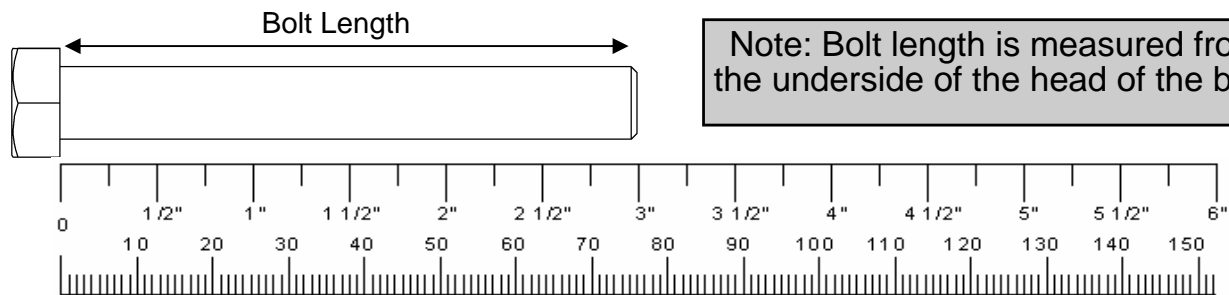
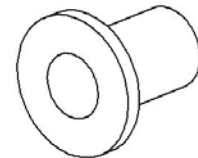
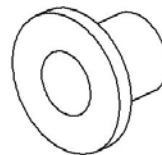
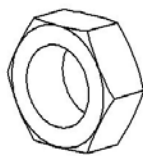
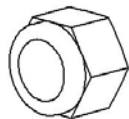
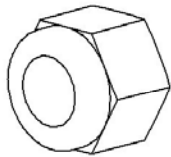
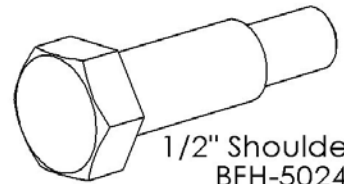
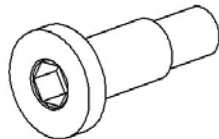
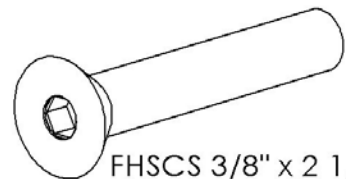
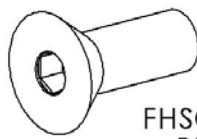

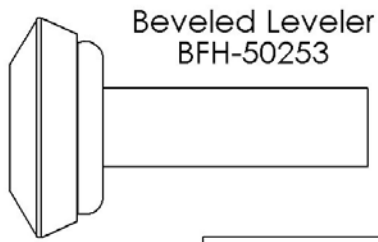

Beveled Leveler
BFH-50253

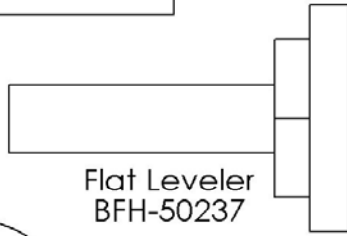

Flat Leveler
BFH-50237

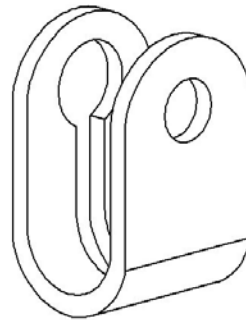

Cable Strap
BFH-50227

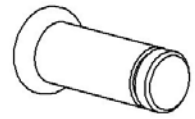

Pin
BFH-50238



Snap Ring
BFH-50239

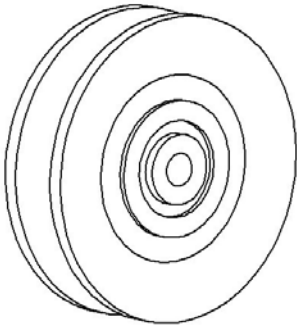

3 1/2" Pulley
BFH-50173

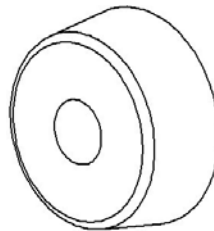

Rubber Donut
BFM-50529

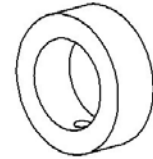

Threaded Collar
BFH-50220

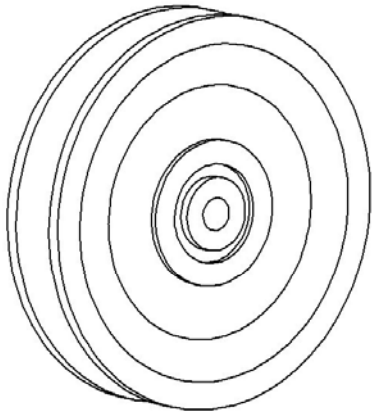

4 1/2" Pulley
BFH-50174

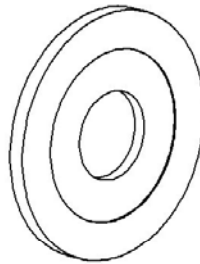

3" Plastic Washer
BFH-50221

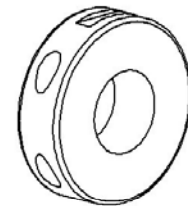

Plastic Collar
BFH-50252

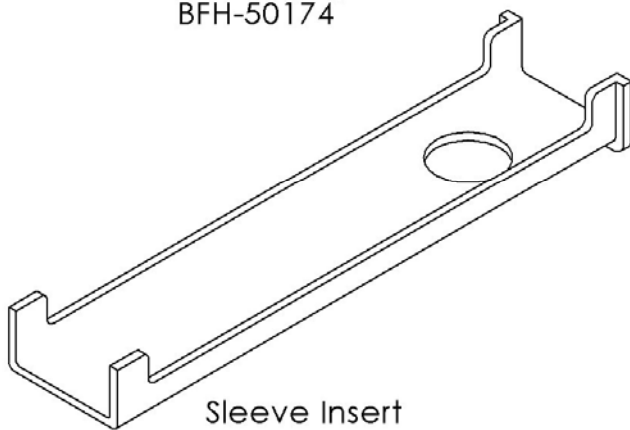

Sleeve Insert
BFH-50175

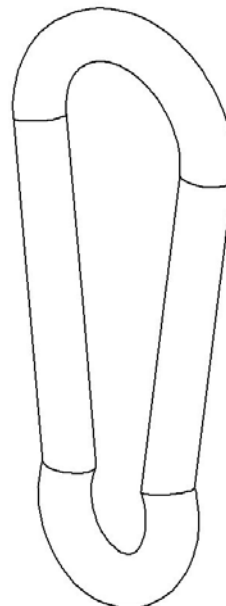

Snap Hook
BFH-50188

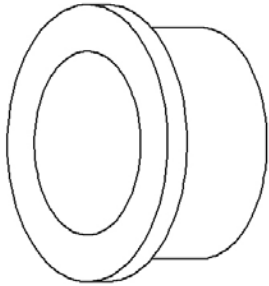

1" Bronze Bushing
BFH-50101

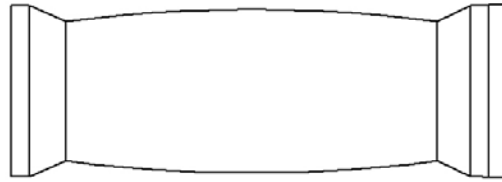

Molded Grip - BFH-50110

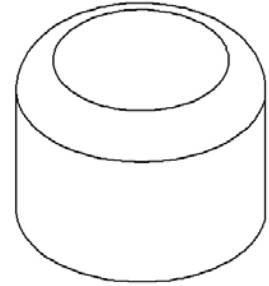

1" Outer Plastic Cap
BFH-50111

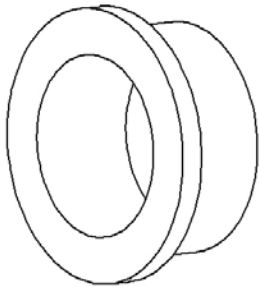

1" Bronze Bushing x 1/2 L
BFH-50297

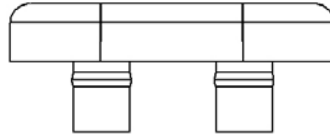

BFH-50222

Rubber Bumpers

BFH-50200

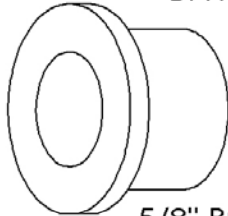
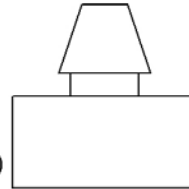

5/8" Bronze Bushing
BFH-50102

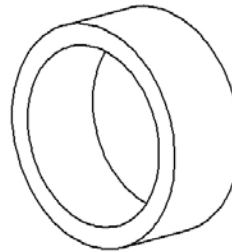

5/8" Spacer
BFM-50247

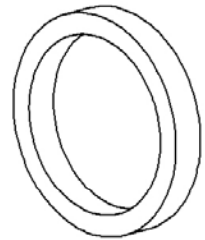

3/16" Spacer
BFM-50246

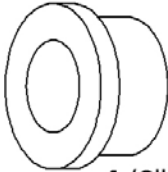

1/2" Bronze Bushing
BFH-50103

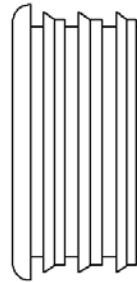

1 1/2" Inner Plastic Cap
BFH-50114



Cable Pivot Bushing
BFH-50248

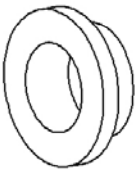

Short 1/2" Bushing
BFH-50244

1" Inner Plastic Cap
BFH-50280

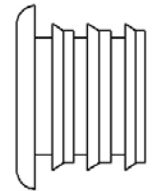

1/2" Snap Ring
BFH-50166

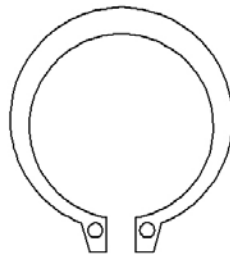

1" Snap Ring
BFH-50165

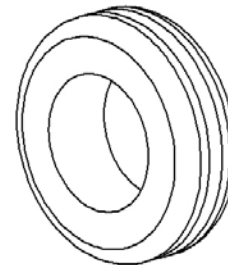

Rubber Grommet
BFH-50199

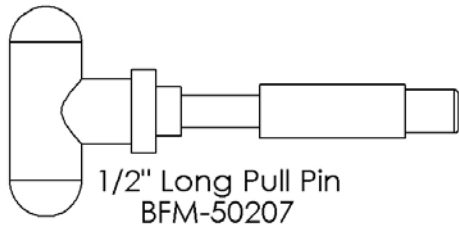

1/2" Long Pull Pin
BFM-50207

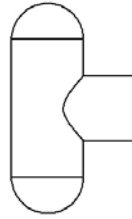

Pull Pin T-Handle
BFH-50263

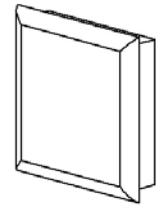

Plastic Cap

Part #	Size
BFH-50211	2" x 2"
BFH-50212	2" x 3"
BFH-50213	1 1/2" x 2"
BFH-50214	1 3/4" x 1 3/4"
BFH-50215	1 1/2" x 1 1/2"

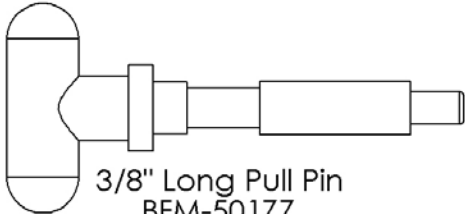

3/8" Long Pull Pin
BFM-50177

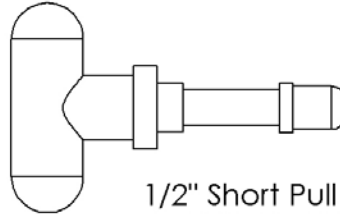

1/2" Short Pull Pin
BFM-50157

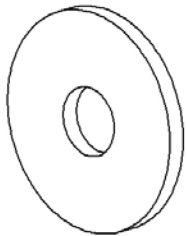

3/8" Fender Washer
BFH-50242

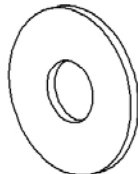

3/8" Flat Washer
BFH-50146



1/2" Flat Washer
BFH-50251

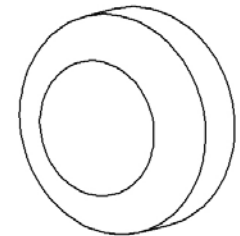

Screw Cap Cover
BFH-50112

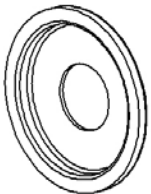

Screw Cap Washer
BFH-50113



3/8" Lock Washer
BFH-50147

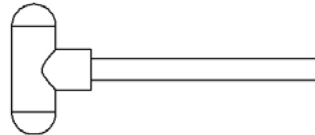

Magnetic Weight Stack Pin
BFC-50127

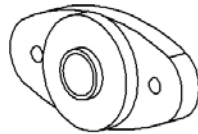

Side Mounted
Flange Bearing
BFH-50171

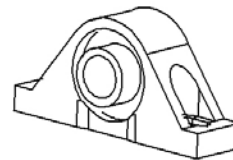

Pillow Block Bearing
BFH-50172

Items not shown.

Part #	Description
BFH-50259	Midnight Black Paint
BFH-50278	Silver Metallic Paint
BFH-50198	Large Logo
BFH-50197	Small Logo
BFH-50236	Foam Grip
BFH-50246	Anti Skid Material
BFH-50262	Silicon Gel Pack
BFC-10101	1 inch chain
BFC-10102	12 inch chain

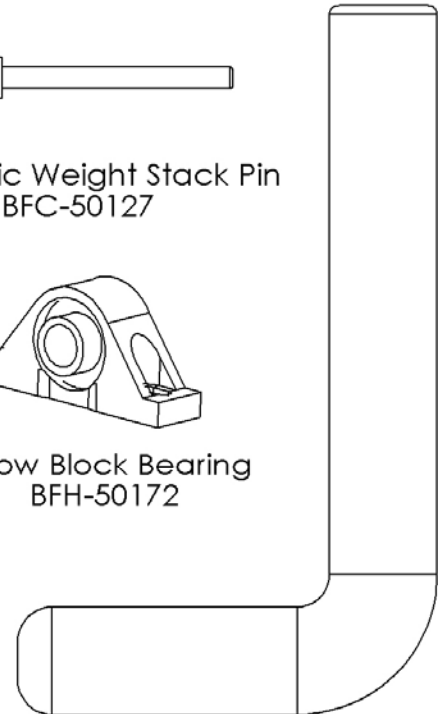

Bar Catch Rubber Sleeve
BFH-50240



PLEASE FOLLOW ALL DIRECTIONS VERY CAREFULLY FOR PROPER INSTALLATION.

Step 1:



Note: For a more consistent appearance, position all bolts in the direction shown in each figure.

- All Flat Washers and Nylocks are 3/8" unless otherwise noted.

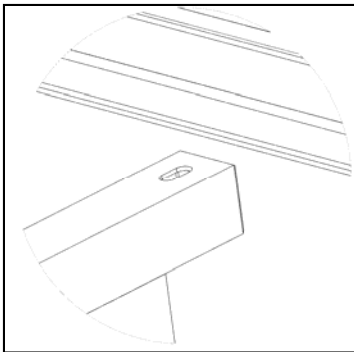

Note: Slot in the rear of the tube on all three Tiers allows for customizing the width according to the width of dumbbells being used on this rack.

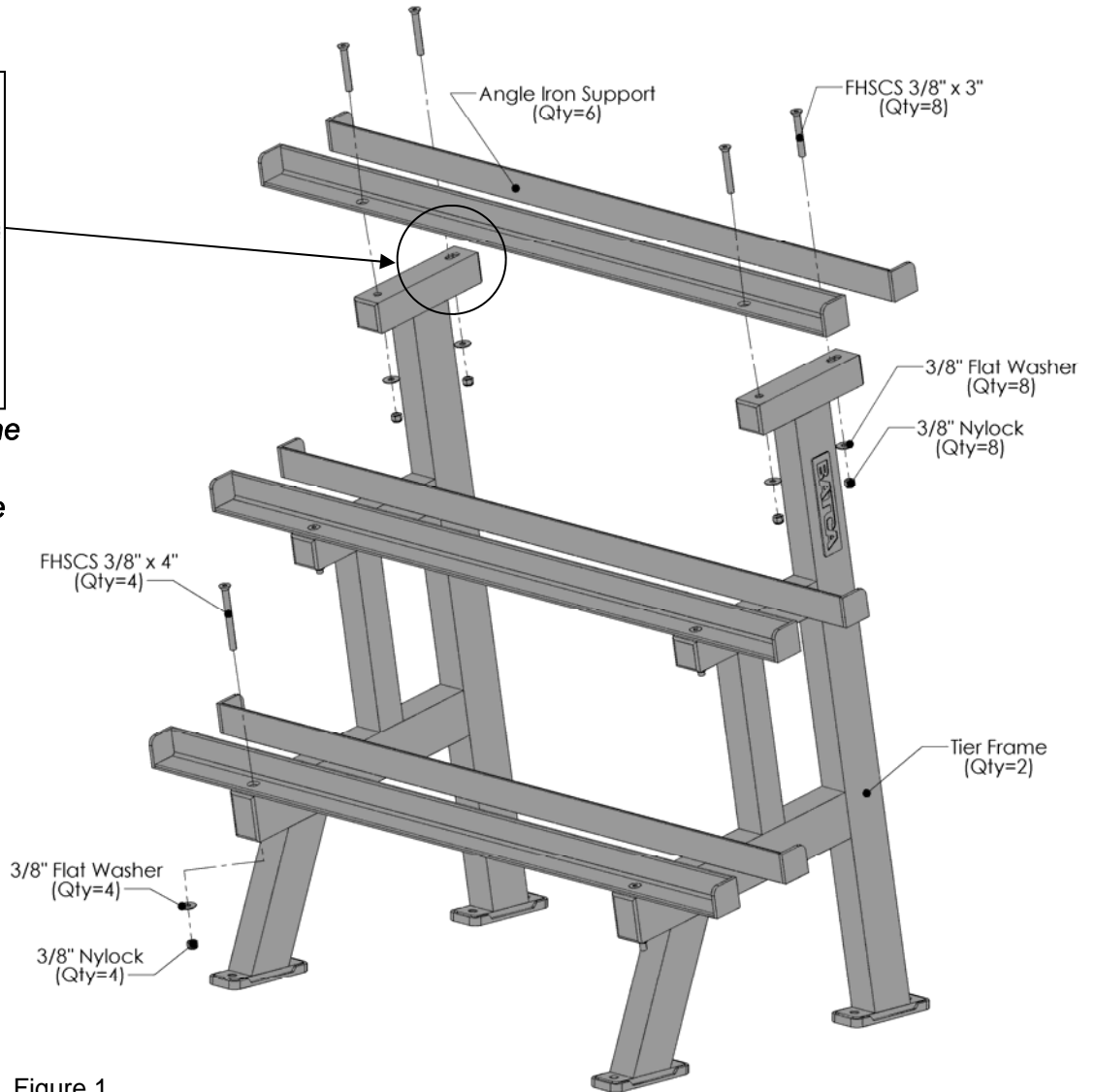

Figure 1

Item #	Part #	Description	Qty
1	BFM-10732	3-Tier Side Frame	2
2	BFM-10730	Angle Iron Support	6
3	BFH-50255	Rubber Foot	4
4	BFH-50251	3/8" Flat Washer Black	12
5	BFH-50265	FHSCS 3/8"-16 X 4"	4
6	BFH-50323	FHSCS 3/8"-16 X 3"	8
7	BFH-50155	3/8"-16 Nylock (Black)	12

Preventive Maintenance

Batca Fitness Systems strives to give you the very best in quality, performance and safety through carefully engineered designs and excellent workmanship. In order to maintain this high level of quality the preventative maintenance schedule below should be followed.

Clean upholstery, grips, and roller pads with mild soap and water generally after every use. The guide rods, chrome slides and frame should be cleaned with a cotton cloth. Upon cleaning the guide rods, a thin layer of Silicone or Teflon gel should be applied to each rod to ensure a glass smooth performance.

An overall inspection should be done before each workout. If the warning and safety decals are worn or have been removed they should be replaced immediately. The cables and cable systems should be inspected for signs of wear and proper tension. In order to check cables properly you should carefully run the cable through your fingertips, checking for signs of wear, cracks, burs and thinning spots. Replace any part at first signs of wear. Cables should be adjusted for proper tension. See assembly instructions for this detail. All hardware, stops, and adjustments should be checked and tightened as required.

The guide rods on your machine should be cleaned and lubricated regularly. This will ensure a glass smooth performance from your weight stack. A thin layer of either Silicone or Teflon gel should applied to each rod. Each pillow block bearing and flange bearing has a grease fittings that must be lubricated regularly. Use general purpose bearing grease and follow the schedule below.

Although cables should be inspected daily, it is important that ALL cables be replaced as directed in the schedule below. Please note that at any first sign of wear the cable should be replaced immediately.

If there are any questions concerning maintenance, please contact your local Batca dealer or contact Batca Fitness Systems directly at:

Batca Fitness Systems

(919) 255-1233

www.batcafitness.com

	Daily		Weekly		Monthly		Quarterly		Years	
	Commercial	Home	Commercial	Home	Commercial	Home	Commercial	Home	Commercial	Home
Clean										
Upholstery										
Hand Grips										
Roller Pads										
Guide Rods										
Chrome Slides										
Frame			X			X				
Inspect										
Overall	X	X								
Safety Decals	X	X								
Cables										
Cable Tension										
Pulleys										
Hardware	X	X								
Stops										
Upholstery										
Hand Grips										
Frame			X			X				
Bushings										
Bearings										
Lubricate										
Guide Rods										
Bearings										
Replace										
Cables										

Limited Lifetime Warranty

What is covered

For Residential Use:

Batca Fitness Systems warrants all of its products against defects in manufacturing, materials and workmanship under normal use and service for one year from date of purchase including paint, chrome, upholstery and grips. Batca Fitness Systems also warrants all cables, belts, bolts, nuts, caps, plugs, bumpers, washers, levelers, decals, gas springs and other hardware for three years after date of purchase; all moving parts, including pulleys, bushings, bearings and pull pins for five years after date of purchase and warrants the frame and all welded parts for the lifetime of the original purchaser.

For Commercial Use:

Batca Fitness Systems warrants all of its products against defects in manufacturing, materials and workmanship under normal use and service for six months from date of purchase including paint, chrome, upholstery and grips. Batca Fitness Systems also warrants all cables, belts, bolts, nuts, caps, plugs, bumpers, washers, levelers, decals, gas springs and other hardware for one year after date of purchase; all moving parts, including pulleys, bushings, bearings and pull pins for three years after date of purchase and warrants the frame and all welded parts for ten years after date of purchase.

What is not covered

This warranty does not cover damage, which results from shipping, misuse, abuse, neglect, carelessness, modification or alteration, accident, fire, flood, "acts of God" or other contingencies beyond the control of Batca Fitness Systems. This warranty also does not cover deterioration from wear and tear or exposure or any defect, which would not have happened if instructions in the owner's manual had been followed. Improper installation, improper assembly or follow-up maintenance along with installation of parts or accessories not originally intended for products of Batca Fitness Systems are also not covered by this warranty. Only genuine Batca parts should be used for replacement, repair, and maintenance for this warranty to apply.

Defective parts will be repaired or replaced at Batca Fitness Systems option, without parts charge to the purchaser. All returns require a return authorization prior to acceptance of repair work. Batca Fitness Systems reserves the right to make design changes without any prior notification and shall not be responsible for incidental or consequential damages.

The purchaser is responsible for shipping the defective part back to the factory. Repair or replacement is the exclusive and sole remedy of the purchaser. Labor charges associated with parts changeovers are not covered by this warranty. Proof of purchase, serial number, model number and date of purchase will be required along with all pertinent information of the alleged damage.

This warranty applies only to the original purchaser and is not transferable. Claims under this warranty must be made directly to Batca Fitness Systems.

Batca Fitness Systems
1207 N. New Hope Road
Raleigh, NC 27610
(919) 255-1233

www.batcafitness.com

Please keep this for your records.

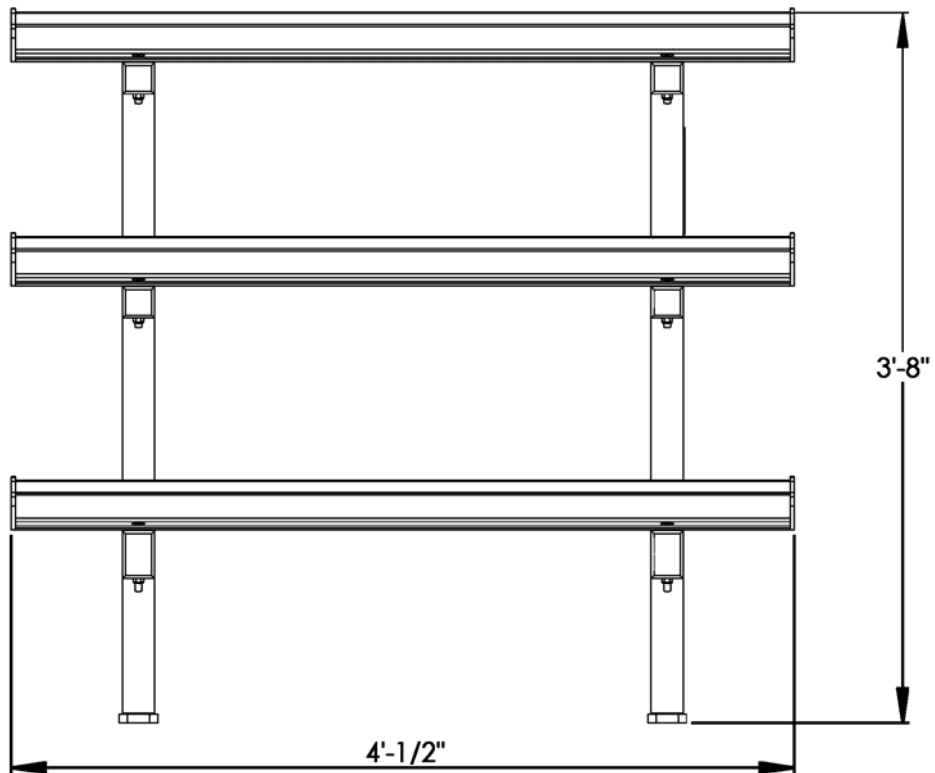
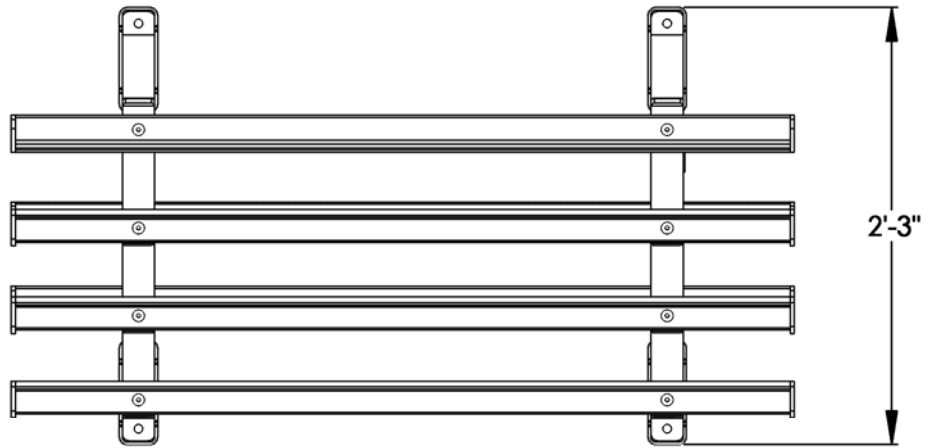

Layout Diagram

The B-6 3 Tier Dumbbell Rack has a layout dimension of 2'-3" (width) x 4'-1/2" (length) x 3'-8" (height). There should be a minimum of 18", preferably 24", of working space around the entire unit.