



FUSION
FREEWEIGHT/BODYWEIGHT

Revision 0
June 2018

3-Tier Dumbbell/Kettlebell Rack
Owner's Manual
FZ-11



Serial Number Here

Date of Purchase



BATCA
fitness systems .usa

Instructions

Congratulations on the purchase of your new Batca FZ-11 3-Tier Dumbbell/Kettlebell Rack. This gym will provide you with a lifetime of enjoyment to meet your strength training needs. Batca Fitness Systems strives to build the best quality gyms and to package these gyms in such a way to avoid any damage during shipping.

In order to get started with your assembly you should first familiarize yourself with this manual. It is recommended that you read through each step thoroughly before you begin. Begin by opening your boxes and separating all of your parts. Verify that all parts are accounted for and have no damage. When all parts are accounted for, you may begin your assembly. Some items may have been pre-assembled for your convenience. Please note that hardware quantities shown reflect total quantities for your gym and may not reflect actual quantities in each bag. Assemble your gym on a solid level surface. This will ensure the best possible performance, function, and safety for the gym and your workout.

Assemble your gym according to the step by step instructions found in this manual. Failure to do so will void your warranty and may result in personal injury. After assembly, you should check each station to ensure correct operation. If a problem arises, recheck your assembly with these instructions to verify correct assembly. If you are unable to correct a problem or have questions with your assembly please contact your authorized Batca dealer.

Warning

Batca Fitness Systems has built this gym to give you a safe, effective and enjoyable workout. However, there is a risk assumed by individuals who use this type of equipment. It is very important that all warnings and instructions are read and followed before beginning any exercise program.

It is also very important to read and follow the preventative maintenance schedule described in this manual. If any of the warning labels or stickers are worn, faded, torn, scratched or missing they should be replaced immediately.

WARNING: There is a risk assumed by individuals who use this type of equipment. To minimize risk always follow these rules.

- 1) It is essential that you consult with your physician before beginning any exercise program.
- 2) Inspect equipment before each use for loose, worn, or frayed parts (including cables, nuts and bolts). Replace parts at first signs of wear (use only genuine BATCA replacement parts). Use of equipment that is damaged, worn, frayed or not completely assembled on a solid, level surface may result in injury.
- 3) Make sure all adjustment pins are fully engaged before using equipment.
- 4) Keep all parts of the body and clothing outside the path of any moving parts of the gym. Be alert to the possibility of injury. Do not be careless.
- 5) Minors and children should not be allowed to play on or around this gym.
- 6) If you have any questions on proper use or maintenance of this gym, do not hesitate to call your local BATCA FITNESS SYSTEMS distributor or BATCA FITNESS SYSTEMS at (919) 255-1233. www.batcafitness.com

Table of Contents

	<u>Page</u>		<u>Page</u>
Instructions	2	Maintenance	5
Tools Required/Hardware Sheet	3	Warranty	6
Dumbbell/Kettlebell Rack Assembly	4	Floor Layout	7

Tools Required

- 9/16" Wrench/Ratchet
- Metric Allen Wrench Set (M8, M6, M4)

Hardware Blister Pack

Step 1:

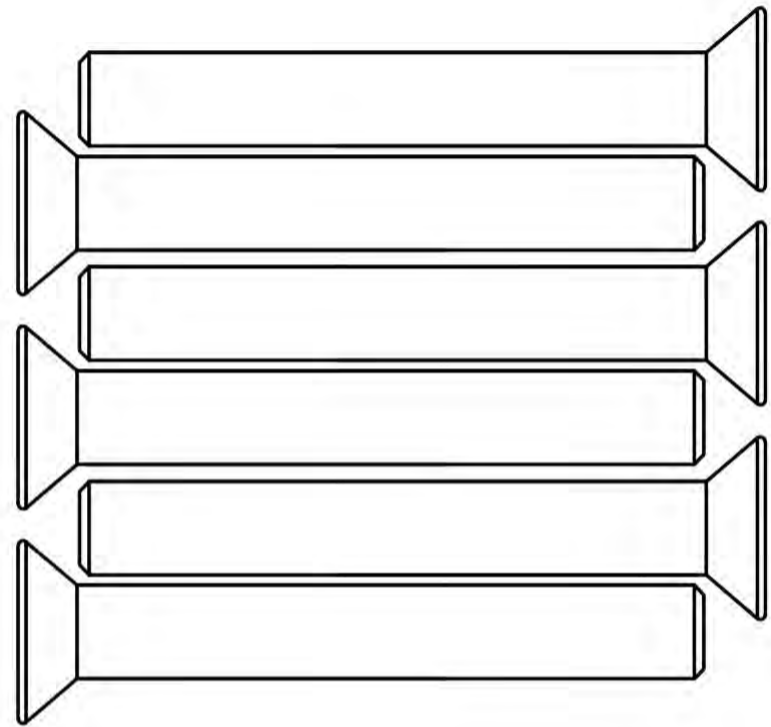
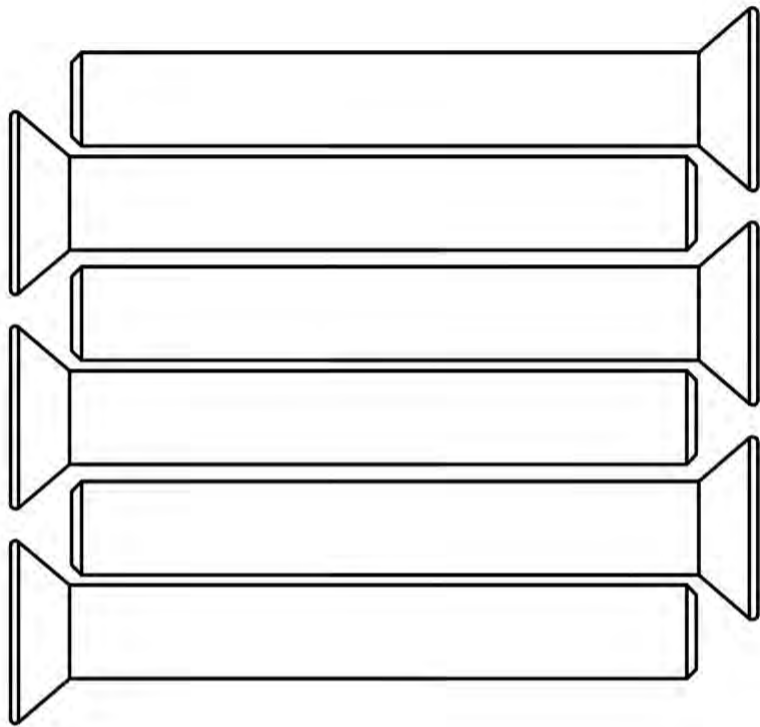

FHSCS 3/8" x 2 3/4"
(QTY=12)

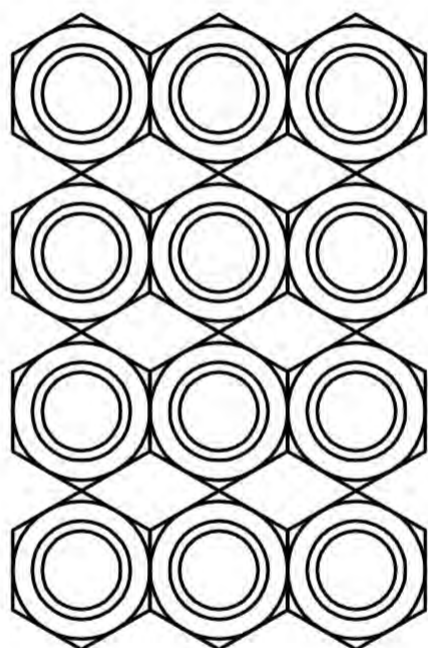

3/8" Nylock
(QTY=12)

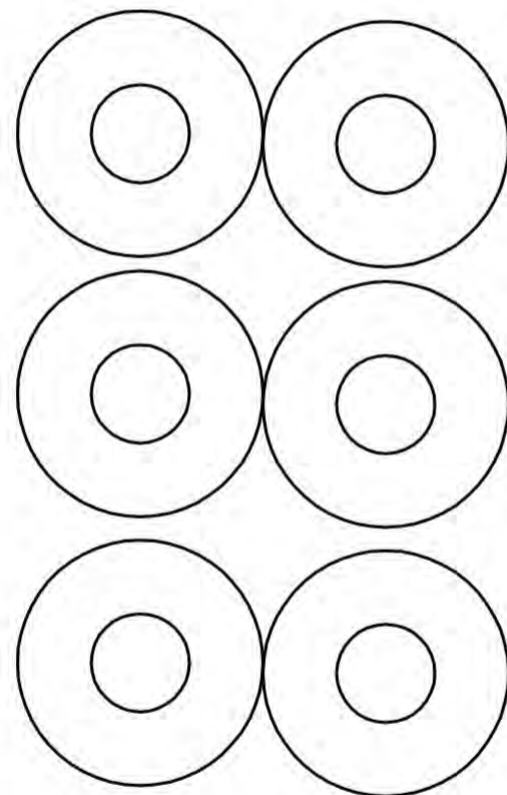

3/8" Flat Washer
(QTY=12)

M6

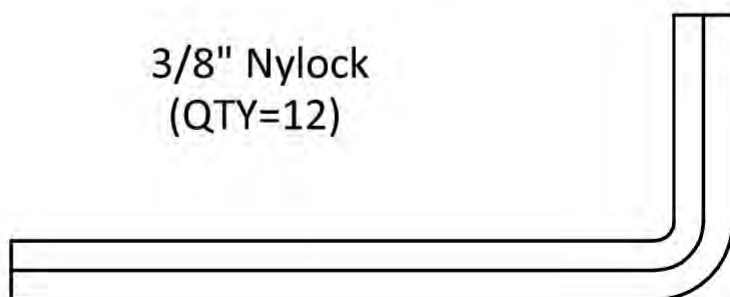



Step 1:

Note: Please Position Hardware in the same direction as shown in the figure. This will make future steps easier to assemble

All Flat Washers and Nylocks are 3/8" unless otherwise noted.

! Please Tighten Bolts before moving to next step.

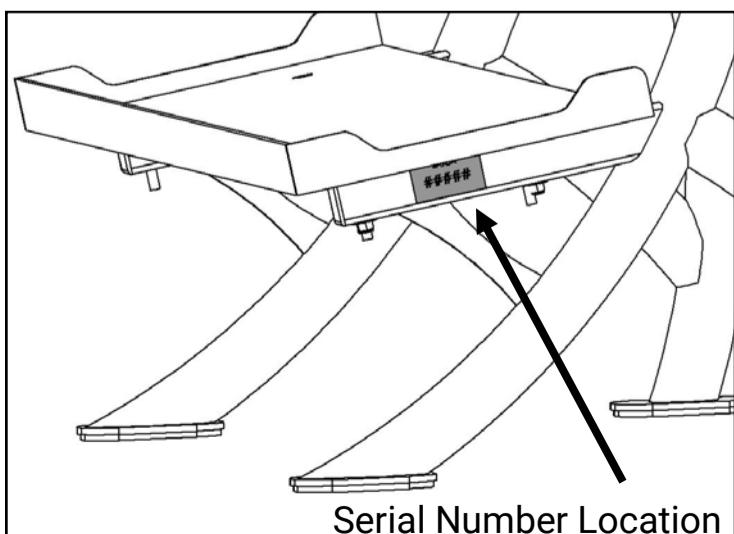
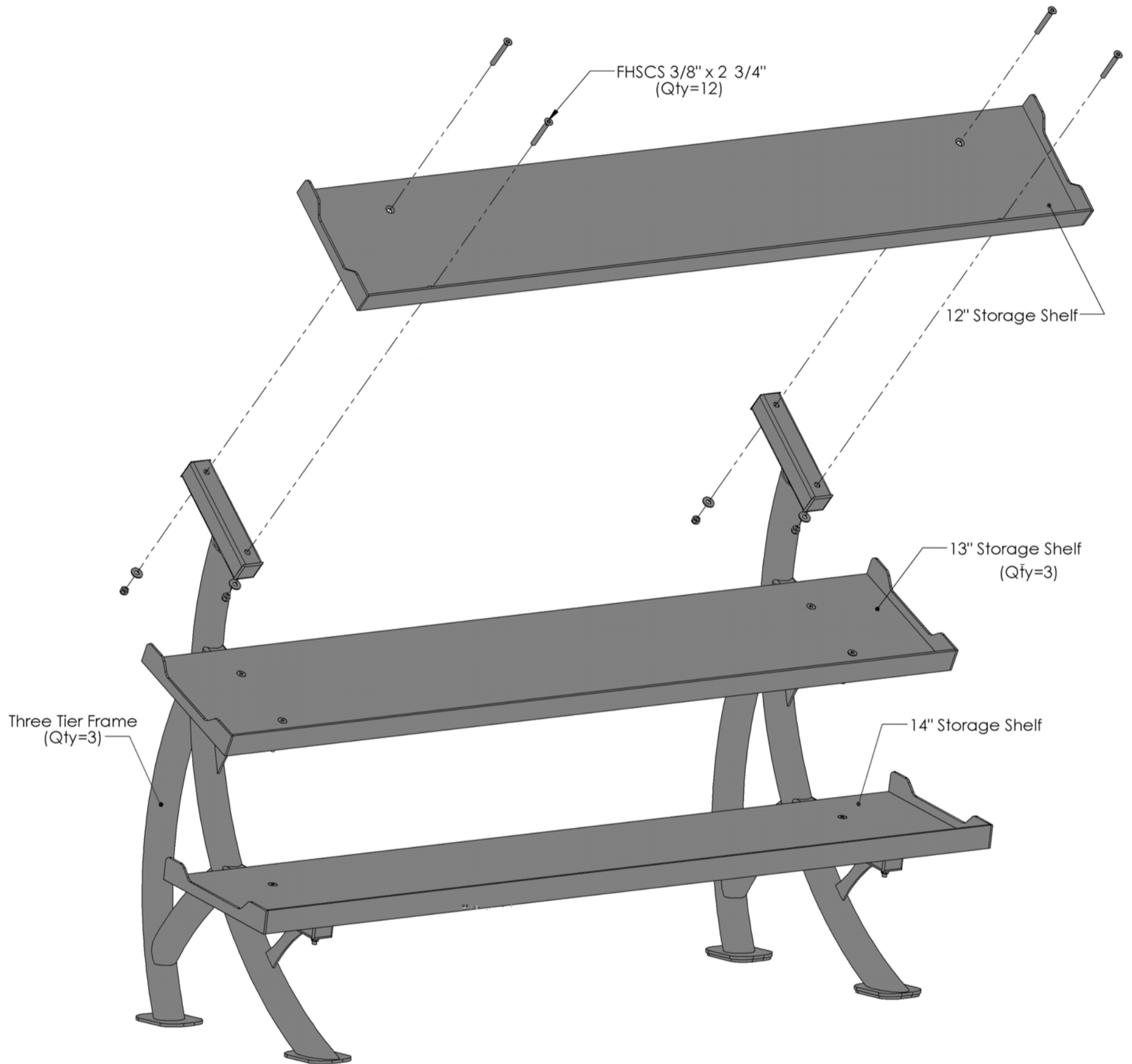

Part #	Description	Qty
BFM-10793	3-Tier Side Frame	2
BFM-11142	12" Storage Shelf	1
BFM-11143	13" Storage Shelf	1
BFM-11144	14" Storage Shelf	1
BFH-51196	FHSCS 3/8"-16 X 2 3/4"	12
BFH-50146	3/8" Flat Washer Black	12
BFH-50157	3/8"-16 Nylock (Black)	12

Preventive Maintenance

Batca Fitness Systems strives to give you the very best in quality, performance and safety through carefully engineered designs and excellent workmanship. In order to maintain this high level of quality the preventative maintenance schedule below should be followed.

Clean upholstery, grips, and roller pads with mild soap and water generally after every use. The guide rods, chrome slides and frame should be cleaned with a cotton cloth. Upon cleaning the guide rods, a thin layer of Silicone or Teflon gel should be applied to each rod to ensure a glass smooth performance.

An overall inspection should be done before each workout. If the warning and safety decals are worn or have been removed they should be replaced immediately. The cables and cable systems should be inspected for signs of wear and proper tension. In order to check cables properly you should carefully run the cable through your fingertips, checking for signs of wear, cracks, burs and thinning spots. Replace any part at first signs of wear. Cables should be adjusted for proper tension. See assembly instructions for this detail. All hardware, stops, and adjustments should be checked and tightened as required.

The guide rods on your machine should be cleaned and lubricated regularly. This will ensure a glass smooth performance from your weight stack. A thin layer of either Silicone or Teflon gel should applied to each rod. Each pillow block bearing and flange bearing has a grease fittings that must be lubricated regularly. Use general purpose bearing grease and follow the schedule below.

Although cables should be inspected daily, it is important that ALL cables be replaced as directed in the schedule below. Please note that at any first sign of wear the cable should be replaced immediately.

If there are any questions concerning maintenance, please contact your local Batca dealer or contact Batca Fitness Systems directly at:

Batca Fitness Systems
(919) 255-1233
www.batcafitness.com

	Daily		Weekly		Monthly		Quarterly		Years	
	Commercial	Home	Commercial	Home	Commercial	Home	Commercial	Home	Commercial	Home
Clean										
Frame			X			X		X		
Inspect										
Overall	X	X								
Safety Decals	X	X	X			X		X		
Hardware	X	X								
Frame			X			X		X		

Limited Lifetime Warranty

What is covered

For Residential Use:

Batca Fitness Systems warrants all of its products against defects in manufacturing, materials and workmanship under normal use and service for one year from date of purchase including paint, chrome, upholstery and grips. Batca Fitness Systems also warrants all cables, belts, bolts, nuts, caps, plugs, bumpers, washers, levelers, decals, gas springs and other hardware for three years after date of purchase; all moving parts, including pulleys, bushings, bearings and pull pins for five years after date of purchase and warrants the frame and all welded parts for the lifetime of the original purchaser.

For Commercial Use:

Batca Fitness Systems warrants all of its products against defects in manufacturing, materials and workmanship under normal use and service for six months from date of purchase including paint, chrome, upholstery and grips. Batca Fitness Systems also warrants all cables, belts, bolts, nuts, caps, plugs, bumpers, washers, levelers, decals, gas springs and other hardware for one year after date of purchase; all moving parts, including pulleys, bushings, bearings and pull pins for three years after date of purchase and warrants the frame and all welded parts for ten years after date of purchase.

What is not covered

This warranty does not cover damage, which results from shipping, misuse, abuse, neglect, carelessness, modification or alteration, accident, fire, flood, "acts of God" or other contingencies beyond the control of Batca Fitness Systems. This warranty also does not cover deterioration from wear and tear or exposure or any defect, which would not have happened if instructions in the owner's manual had been followed. Improper installation, improper assembly or follow-up maintenance along with installation of parts or accessories not originally intended for products of Batca Fitness Systems are also not covered by this warranty. Only genuine Batca parts should be used for replacement, repair, and maintenance for this warranty to apply.

Defective parts will be repaired or replaced at Batca Fitness Systems option, without parts charge to the purchaser. All returns require a return authorization prior to acceptance of repair work. Batca Fitness Systems reserves the right to make design changes without any prior notification and shall not be responsible for incidental or consequential damages.

The purchaser is responsible for shipping the defective part back to the factory. Repair or replacement is the exclusive and sole remedy of the purchaser. Labor charges associated with parts changeovers are not covered by this warranty. Proof of purchase, serial number, model number and date of purchase will be required along with all pertinent information of the alleged damage.

This warranty applies only to the original purchaser and is not transferable. Claims under this warranty must be made directly to Batca Fitness Systems.

Batca Fitness Systems
1207 N. New Hope Road
Raleigh, NC 27610
(919) 255-1233

www.batcafitness.com

Please keep this for your records.



Scan the QR Code to
register your new
BATCA Product online!

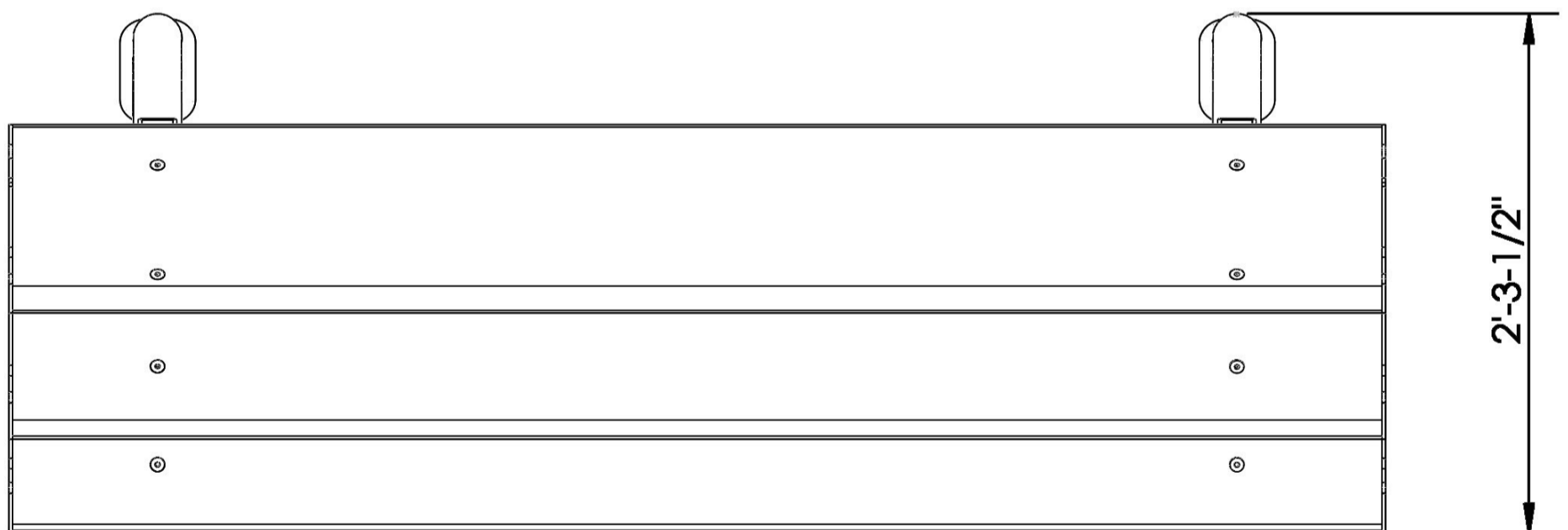
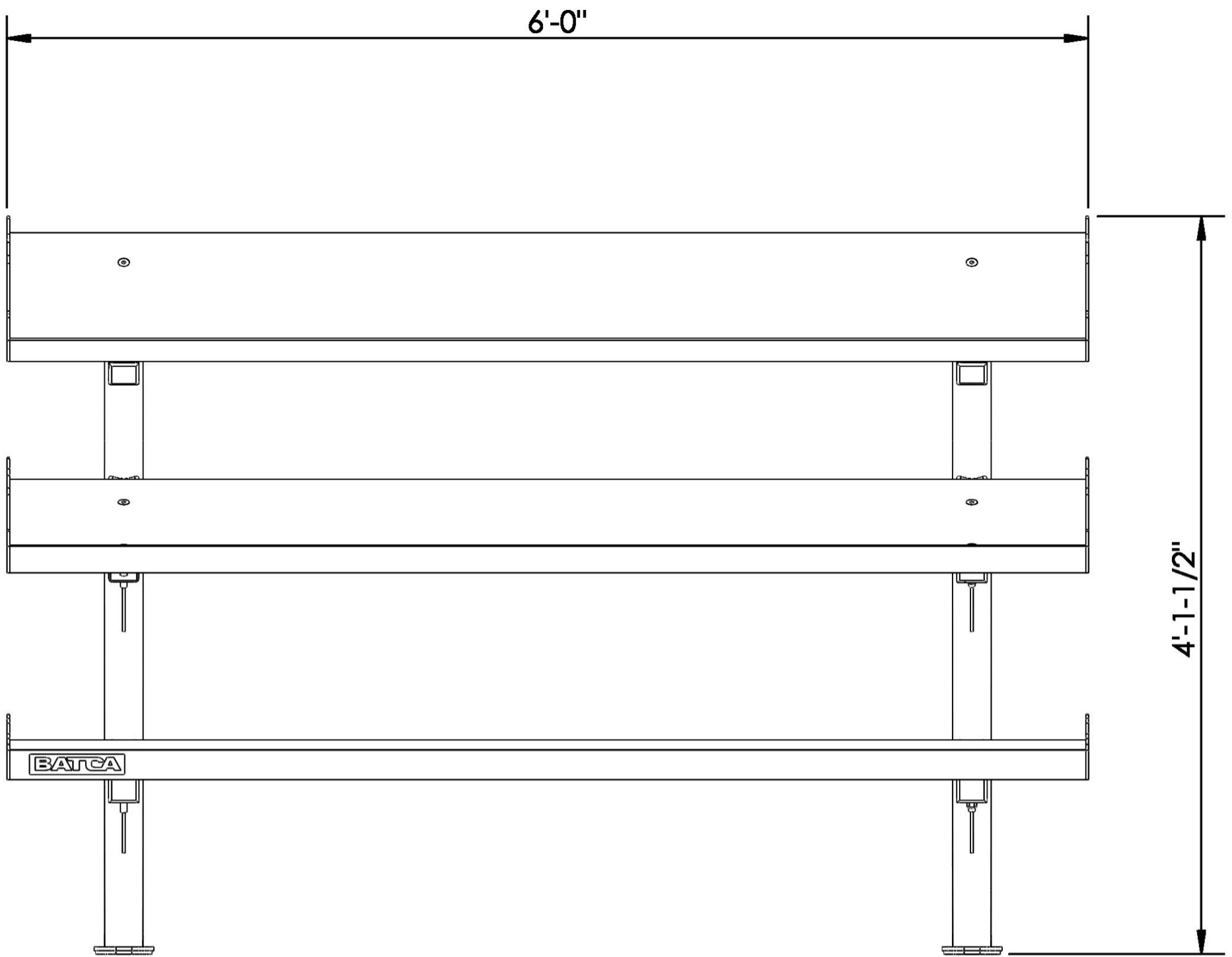

Layout Diagram

The FZ-11 3-Tier Dumbbell/Kettlebell Rack has a layout dimension of 2'-3 1/2" (width) x 6'-0" (length) x 4'-1 1/2" (height). There should be a minimum of 18", preferably 24", of working space around the entire unit.